



徐工徐工 助您成功
XCMG FOR YOUR SUCCESS



SUNIGHT
Create Value For Customers

sunightmachinery.com

LW156FV

轮式装载机
Wheel loader



徐工铲运机械事业部
XCMG EARTH MOVING MACHINERY BUSINESS UNIT



产品简介 Product Introduction



- ▼ LW156FV是徐工集团自主研发的产品，配置国二阶段发动机，高品质分体式双变，四轮驱动，全液压转向，动力强劲，效率更高，环境适应能力更强。

LW156FV is a product independently researched and developed by XCMG. It is equipped with national two-stage engine, high-quality split type double change, four-wheel drive, full hydraulic steering, strong power, higher efficiency and stronger environmental adaptability.

- ▼ 液压油更换周期延长至2000小时，远超同行业水平，大大降低用户使用成本。
The replacement period of the hydraulic oil is extended to be 2000h, which is far beyond the same industry level and greatly reduces the using cost.

性能特长 Performances and specialties

- ▼ 采用长轴距（2300mm）设计，适应各类超重工况，稳定性行业领先。
The replacement period of the hydraulic oil is extended to be 2000h, which is far beyond the same industry level and greatly reduces the using cost.
- ▼ 超过3米的卸载高度，满足各种场合作业需要。
The unloading height is more than 3m, which meets all kinds of operation.
- ▼ 整体油缸、销轴经过调质淬火工艺处理，硬度领先同行，可靠性高。
As the overall oil cylinder and pin is tempered and quenched, the hardness leads in the industry and its reliability is high.

机型特点 Model characteristics

- ▼ 徐工特有重载型传动部件，勇担重责。
Overloaded transmission parts are special.
- ▼ 流线型外观，大视野玻璃，造型美观。
Streamlined appearance and wide-field glass are attractive.
- ▼ 以人为本的设计，确保安全，降低疲劳，为您营造绝佳操作环境。
Due to people-oriented design, it is safe and fatigue-reducing, which creates the excellent operating environment for you.
- ▼ 采用单手柄操作，座椅可调，操作舒适。
It is operated by the single handle, the seat is adjustable, and it is operated comfortably.
- ▼ 接头采用24°锥+密封圈的双重密封形式，密封性更好，性能更加可靠；管路进行集中梳理，走向更加合理。
Double seal with 24° cone+seal ring is adopted for the joint. The sealing performance is better, and the performance is more reliable; the pipelines are cleared up centrally and the pipeline route is more rational.
- ▼ 国三发动机，动力强劲，效率高，电控高压共轨技术真正达到节油降耗。
National III engine has strong power and high efficiency. Due to electronic high-pressure and common-rail technology, oil consumption is reduced.
- ▼ 经过CAE优化的工作装置，自动放平功能强，作业流畅，连续作业时铲斗的角度能够轻松插入料堆，省力高效。
Due to CAE optimized working device, it can be automatically flattened and operates smoothly. During continuous operation, the bucket can be easily inserted into the material pile, which saves labor and becomes efficient.

澎湃动力 Model characteristics

- ▼ LW156FV小型装载机主动力云内YN27GBZ发动机。
LW156FV The engineering version of small loader is powered by YN27GBZ Yunnei engine.
- ▼ 涡轮增压, 55kW, 马力强劲, 扭矩储备系数大, 满足施工过程中瞬间超负荷要求, 充分提供重载、大负荷作业所需动力。
Turbocharger, 55kW and with large horsepower and large torque reserve coefficient, meets the instantaneous overload requirements during construction. Besides, it provides the power required for the overloading and heavy-load operation.



性能卓越的加强型重载驱动桥

Reinforced heavy-load drive axle with excellent performance

- ▼ 各承载部位饱满、厚实, 整体式齿圈, 大模数齿轮, 具有良好的抗过载能力, 满足各种高强度、高负荷作业需要。
The load-bearing parts are full and thick. The overall gear ring and large module gear have good capability of overload resistance, which meets the high-strength and high-load operation need.

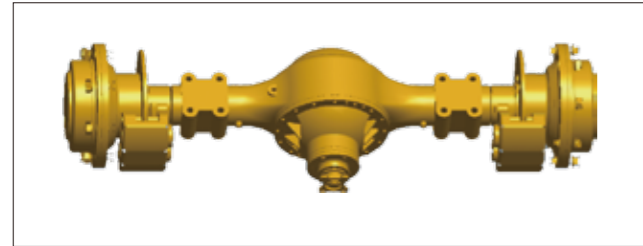

国际品质液压、电器元件

Reinforced heavy-load drive axle with excellent performance

- ▼ 液压部件全部采用国内顶级品牌。
Hydraulic parts are of the domestic top brands.
- ▼ 线束采用高品质材料, 优化工艺布局, 确保电路系统可靠。
Harness is made of high-quality material. The process layout is optimized and the circuit system is reliable.
- ▼ 采用国际品质液压胶管, 耐热、抗压, 寿命长。
International-quality hydraulic hose that is resistant to heat and pressure and has long service life is adopted.
- ▼ 液压管路采用国际DIN标准24°锥加O型圈两道密封, 密封性更好, 有效解决渗漏难题。
The hydraulic pipeline is sealed with international DIN standard 24° cone and O seal ring, which means sealing is better and leakage is effectively eliminated.



徐工专用变速箱、变矩器

XCMG special gearbox and torque converter

- ▼ 专用大容量变矩器, 确保发动机动力被最大程度利用。
Due to special large-capacity torque converter, the engine power is utilized to be maximum.
- ▼ 加强型设计, 有效提升变速箱超载能力。
Due to enhanced design, the overload capacity of gearbox is effectively enhanced.
- ▼ 定轴式变速箱, 可靠、高效, 维修方便。
Fixed shaft gearbox is reliable and efficient and is easy to repair.



坚实可靠的超强重载型结构件

Solid and reliable super-heavy-loaded structural parts

- ▼ 重载设计, 厚板结构, 机器人焊接, 抗扭系数高, 过载能力强。
Heavy-loaded design, thick board, robot welding, high torsion-resistant efficiency, strong overload capacity.
- ▼ 采用有限元分析技术, 减少应力集中, 消除局部薄弱, 车架耐冲击、抗超载, 各种超重工况游刃有余。
Adopt the finite element analysis technique, reduce the stress concentration, eliminate the local weakness. The frame is resistant to shock and overload. It is suitable for various overloading conditions.
- ▼ 主铰接点近似对中设计, 减小转弯半径, 降低轮胎磨损和能量损耗。
Due to approximate centering design on the main hinge point, the turning radius is reduced, tire wear and energy loss are reduced.



维修保养轻松便捷

Easy and convenient to repair and maintain

- ▼ 可开启的前翻后机罩, 发动机及水箱完全暴露, 检修维护方便、便捷。
Due to the openable hood that is opened from front to back, the engine and water tank are completely exposed and it is easy and convenient to repair and maintain.
- ▼ 油位检查、油液添加及润滑脂加注点均布置在易于接近部位, 空滤器滤芯易检、易换。
Oil level inspection, oil filling and grease filling points are arranged in accessible parts. The air filter core is easy to check and change.
- ▼ 系统压力检测口引出, 维护保养省时、省力。
Due to being guided out from the system pressure detection port, it saves time and labor during repair and maintenance.
- ▼ 集中式保险丝盒, 电器系统运行状况集中显现, 维护方便。
Due to centralized fuse box, the running state of electric system is displayed centrally and it is easy to maintain.

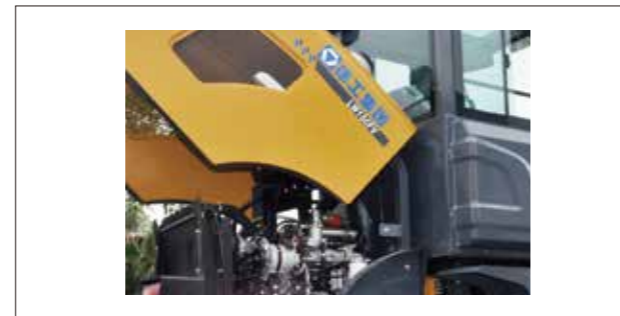

宽敞舒适的驾驶空间

wide and comfortable driving space

- ▼ 驾驶室空间大, 无视野障碍, 密封性好, 噪声疲劳大大降低。
The cab has large space and has no visual obstruction. It is sealed well and the noise fatigue is greatly reduced.
- ▼ 可调节座椅、标配风扇, 适配冷暖空调, 操作舒适, 提升工作效率。
Due to adjustable seats, standard fan and suitable air conditioner, it is operated comfortably and the working efficiency is enhanced.
- ▼ 集中式仪表盘, 操作更加方便。
Due to centralized dashboard, it is more convenient to operate.
- ▼ 工作装置单手柄控制, 操作舒适性好。
The working device is controlled by the single handle and it is operated comfortably.
- ▼ 隔音降噪处理, 整机驾驶室内噪音低, 安全舒适。
Due to sound insulation and noise reduction, the cab has low noise, and it is safe and comfortable.



多种配置属具适应不同作业要求

Multiple accessories are configured to meet different operation requirements

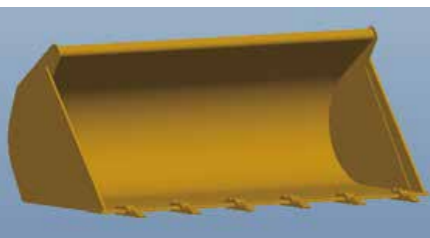
属具名称 Name of accessory		标准斗 Standard bucket	
Picture of accessory 属具图片			
	斗容 Bucket capacity	m ³	0.7
参数 Parameters	外形尺寸 (长×宽×高) Dimensions (length×width×height)	mm	910×2060×760
	属具重量 Weight of accessory	kg	260

属具名称 Name of accessory		软包夹 Soft clamps	
Picture of accessory 属具图片			
	外形尺寸 (长×宽×高) Dimensions (length×width×height)	mm	1520×1210×580
参数 Parameters	属具重量 Weight of accessory	kg	240
	最大张开距离 Maximum open distance	mm	1500

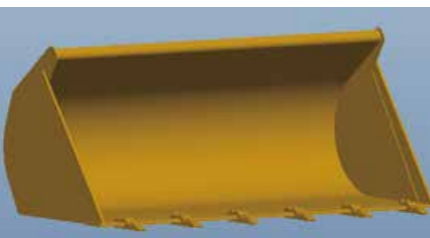

属具名称 Name of accessory		装夹斗 Clamping bucket	
Picture of accessory 属具图片			
	斗容 Bucket capacity	m ³	0.7
参数 Parameters	外形尺寸 (长×宽×高) Dimensions (length×width×height)	mm	900×2060×910
	属具重量 Weight of accessory	kg	450
	张口尺寸 Open size	mm	1600

属具名称 Name of accessory		工程斗 Engineering bucket	
Picture of accessory 属具图片			
	斗容 Bucket capacity	m ³	0.9
参数 Parameters	外形尺寸 (长×宽×高) Dimensions (length×width×height)	mm	1020×2060×820
	属具重量 Weight of accessory	kg	290

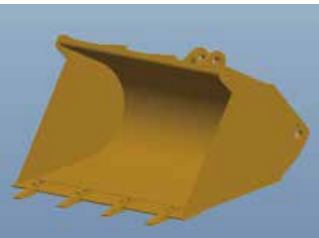
属具名称 Name of accessory		货叉 Fork	
Picture of accessory 属具图片			
	叉齿长度 Fork tooth length	mm	1070
参数 Parameters	外形尺寸 (长×宽×高) Dimensions (length×width×height)	kg	1490×1480×1250
	属具重量 Weight of accessory	mm	475

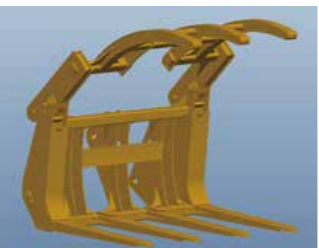
属具名称 Name of accessory		限宽斗 Rationing bucket	
Picture of accessory 属具图片			
	斗容 Bucket capacity	m ³	0.4/0.5
参数 Parameters	外形尺寸 (长×宽×高) Dimensions (length×width×height)	mm	1020×1150×820/ 1020×1170×820
	属具重量 Weight of accessory	kg	190/210

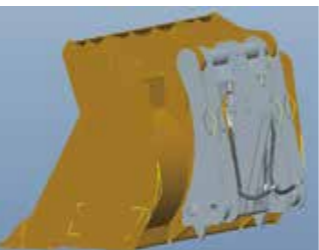
属具名称 Name of accessory		多齿抓草机 Multi-tooth grass grasping machine	
Picture of accessory 属具图片			
	外形尺寸 (长×宽×高) Dimensions (length×width×height)	mm	1440×1760×1160
参数 Parameters	叉齿长度 Fork tooth length	mm	1000
	属具重量 Weight of accessory	kg	475
	最大张口尺寸 Maximum open size	mm	1600
	最小抱圆直径 Minimum grab diamete	mm	470

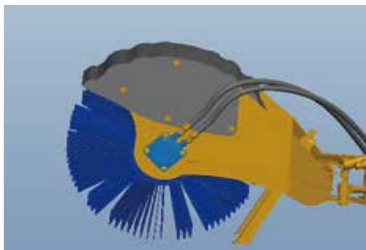
属具名称 Name of accessory		快换装置 Quick change device		属具名称 Name of accessory		清扫器 Sweeper		
Picture of accessory 属具图片					Picture of accessory 属具图片			
	快换装置类型 Quick change device type		快换铲斗 Quick change bucket	快换货叉 Quick change fork		参数 Parameters	外形尺寸 (长×宽×高) Dimensions (length×width×height)	mm
外形尺寸 (长×宽×高) Dimensions (length×width×height)		mm	1120×2060×900	1630×1200×1110	工作宽度 Working width		mm	1830
斗容 Bucket capacity		m ³	0.7	/	毛刷直径 Brush diameter		mm	800
叉齿长度 Fork tooth length		mm	/	1050	属具重量 Weight of accessory		kg	450
属具重量 (含托架) Dimensions (length×width×height)		kg	450	430	马达流量 Motor flow		L/min	150
					驱动系统 Drive system		/	液压马达直驱 Hydraulic motor drive

主要参数 (标准斗) Main parameters (standard bucket)

项目 Item	短臂型 Short boom	标准型 Standard boom	高卸型 Long boom	单位 Units	
额定载荷 Rated load	1200	1100	1000	kg	
倾翻载荷 Tipping load	2400	2200	2000	kg	
卸载高度 Unloading height	铲斗平高 Bucket flat height	3470	3740	3870	mm
	标准 Standard	3000	3300	3500	mm
卸载距离 Unloading distance	785	830	1070	mm	
额定斗容 Rated bucket capacity		0.7		m ³	
整机工作质量 Overall mass	4450	4550	4650	kg	
轴距 Wheelbase		2300		mm	
轮距 Tread		1500		mm	
最大提升时的铰销高度 Maximum hoisted hinge pin height	3730	3920	4190	mm	
最大掘起力 Maximum breakout force		44		kN	
最大牵引力 Maximum traction		40			
动臂提升时间 Boom hoisting time		5.5		s	
三项和时间 Three items and time		9		s	
最小转弯半径 (轮胎中心) Minimum turning radius (tire center)		4620		mm	
铰接角度 Articulation angle		35		°	
爬坡能力 Climbing capacity		25		°	
最小离地间隙 Minimum ground clearance		260		mm	
轮胎规格 Tire specification		16/70-16		-	
整机外形尺寸 (长×宽×高) Overall dimensions (length×width×height)	5890×2060×2900	6140×2060×2900	6390×2060×2900	mm	
发动机 Engine	型号 Model	YN27GBZ		-	
	额定功率/转速 Rated power/speed	50/2400		kW/rpm	
行驶速度 Driving speed	一档 (前进/后退) First position (drive/back)	8		km/h	
	二档 (前进/后退) Second position (drive/back)	20.5		km/h	

随技术进步, 样本内容、产品结构、配置参数等将不断改进, 恕不另行通知。样本信息与实物存在差异的, 以实物为准。
As the sample content, product structure and configuration parameters will be continuously improved due to technological changes, please subject to change without prior notice. In case of difference between the sample information and physical objects, please subject to the physical objects.