



徐工徐工 助您成功
XCMG FOR YOUR SUCCESS

XCMG | Machmall.com

Web: machmall.com
Tel: +86-516 8773 9797
E: machmall@xcmg.com

XCMG
徐工集团

LW160FV

轮式装载机 Wheel loaders

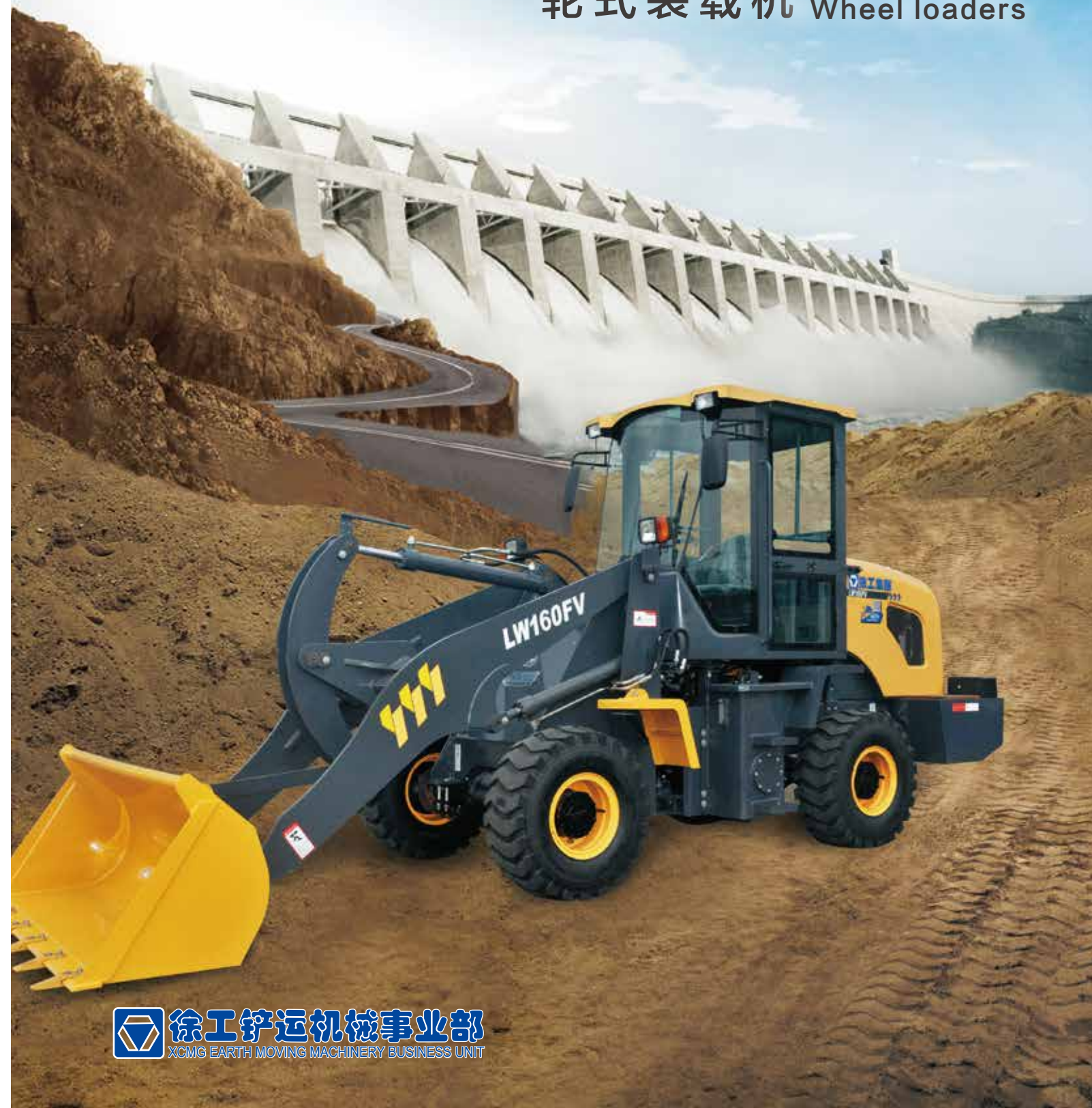

徐工铲运机械事业部
XCMG EARTH MOVING MACHINERY BUSINESS UNIT



产品简介 Product introduction



- ▼ LW160FV 是徐工集团自主研发的产品，配置大功率国二发动机，高品质分体式双变，四轮驱动，全液压转向，动力强劲，效率更高，环境适应能力更强。
LW160FV is a product independently developed by XCMG. It is equipped with high-power Guoer engine, high-quality split type double change, four-wheel drive, full hydraulic steering, strong power, higher efficiency, and stronger environmental adaptability.
- ▼ 可选多种工作装置及附属机具，实现一机多能，广泛应用于基建、环卫、农田、道路整修、港口、货场等地的装载、牵引及起重、运输等作业。
Optional working device and attached tools fit for multifunctional purposes, such as: infrastructure, sanitation, farming, ports, freight yards loading, towing and lifting operations tec..
- ▼ 液压油更换周期延长至 2000 小时，远超同行业水平，大大降低用户使用成本。
The hydraulic oil change interval are extended to 2000 hrs exceeding the level in the same business, which greatly reduced customers cost.

性能特长 Characteristics

- ▼ 采用长轴距（2350mm）设计，适应各类超重工况，稳定性行业领先。
The long wheel base design (2350mm) adopts various heavy duty working conditions.
- ▼ 铲掘有力（掘起力 $\geq 44\text{kN}$ ），破断力强，各种物料举重若轻。
Strong shovels (breakout force $\geq 44\text{kN}$) to break all kinds of material down easily.

- ▼ 快速高效，行驶速度高达 20.5km/h，行业较优。
Fast travel speed up to 20.5km/h leads the business.
- ▼ 超过 3 米的卸载高度，满足各种场合作业需要。
Discharge height over 3m could meets all operation sites requirements.

机型特点 Model features

- ▼ 徐工特有重载型传动及结构部件，勇担重责。
XCMG special heavy duty drive parts
- ▼ 全新优化的工作装置，挑战小型装载机效率极限。
Newly optimized working device challenges small wheel loader limits.
- ▼ 流线型外观，大视野玻璃，圆弧配重，造型美观。
Streamlined appearance, large field glasses
- ▼ 以人为本的设计，确保安全，降低疲劳，为您营造绝佳操作环境。
Ergonomic design to ensure safety, reduce fatigue and create comfort operating environment.
- ▼ 采用单手柄操作，可配暖风、空调等，操作舒适。
Single handle operation and optional heater and AC.

澎湃动力 Strong power

- ▼ 工程版小型装载机主动力云内发动机，云内总厂生产。
The engineering version of small loader is mainly powered by Yunnei engine, which is produced by Yunnei General Factory.
- ▼ 涡轮增压，马力强劲，扭矩储备系数大，满足施工过程中瞬间超负荷要求，充分提供重载、大负荷作业所需动力。
Turbocharged and strong power meets transient overload requirement, being able to provide heavy duty and high load power.

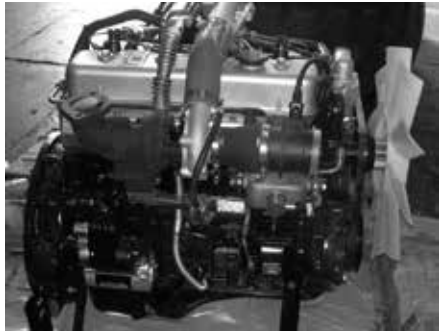

性能卓越的加强型重载驱动桥 Outstanding strengthened heavy duty drive axle

- ▼ 各承载部位饱满、厚实，整体式齿圈，大模数齿轮，具有良好的抗过载能力，满足各种高强度、高负荷作业需要。
Thick and robust bearing parts, integrated gear rings, large module gears meets all intensive and high load working requirements.

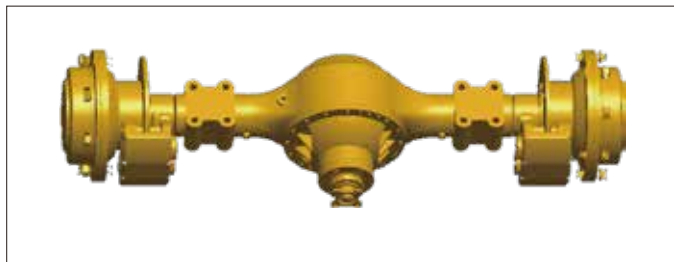

国际品质液压、电器元件 International quality hydraulics and electric parts

- ▼ 液压部件全部采用国内顶级品牌。
Top brand hydraulics parts in China
- ▼ 线束采用高品质材料，优化工艺布局，确保电路系统可靠。
High quality harness material and optimized routing ensure system reliability.
- ▼ 采用国际品质液压胶管，耐热、抗压，寿命长。
International quality hydraulic hoses with features of heat resistance, pressure resistance and long service life.
- ▼ 液管管路采用国际 DIN 标准 24° 锥加 O 型圈两道密封，密封性更好，有效解决渗漏难题。
International DIN standard 24° tape+ O sealing ring double sealing with better sealing performance.



徐工专用变速箱、变矩器 XCMG transmission, converter

- ▼ 专用大容积变矩器，确保发动机动力被最大程度利用。
Special large capacity converter ensures engine power is farthest used.
- ▼ 加强型设计，有效提升变速箱超载能力。
Strengthened designs improve overload capacity of the transmission.
- ▼ 定轴式变速箱，可靠、高效，维修方便。
Reliable, efficient fixed-shaft transmission



坚实的超强的重载型结构件 Reliable super strong heavy duty structural parts

- ▼ 重载设计，厚板结构，机器人焊接，抗扭系数高，过载能力强。
Heavy duty design, thick plate structure, robots welded, high torsional coefficient and strong overload capacity.
- ▼ 采用有限元分析技术，减少应力集中，消除局部薄弱，车架耐冲击、抗超载，各种超重工况游刃有余。
FEM analysis is adopted to reduce stress focus, eliminating local weakness for impact resistance and anti-overload frame under super heavy duty working conditions.
- ▼ 主铰接点近似对中设计，减小转弯半径，降低轮胎磨损和能量损耗。
Main hinges are close to centered design to reduce turning radius, tires wearing and energy loss.

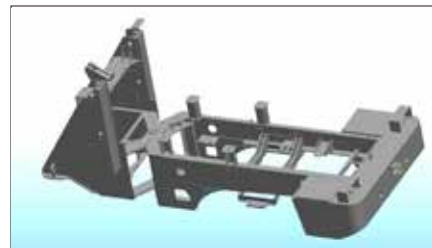

维修保养轻松便捷 Easy and quick maintenance

- ▼ 可开启的前翻后机罩，发动机及水箱完全暴露，检修维护方便、便捷。
Front tilted engine hood, exposed engine and water tank make the maintenance effortless.
- ▼ 油位检查、油液添加及润滑脂加注点均布置在易于接近部位，空滤器滤芯易检、易换。
Oil level check, oil filling and grease injection points are all approachable, air filter elements are easy to be checked and replaced.
- ▼ 系统压力检测口引出，维护保养省时、省力。
System pressure being tested at ports make the maintenance effortless
- ▼ 集中式保险丝盒，电器系统运行状况集中显现，维护方便。
Centered fuse box to display electric system running status





宽敞舒适的驾驶空间 Spacious driving space

- ▼ 驾驶室空间大，无视野障碍，密封性好，噪声疲劳大大降低。
Large cabin space without obstruction to vision field, bettered sealing and greatly reduced noise and fatigue.
- ▼ 可调座椅、标配风扇，适配冷暖空调，操作舒适，提升工作效率。
Adjustable seat, standard fan and AC improve working efficiency
- ▼ 集中式仪表盘，操作更加方便。
Centered dashboard eases the operation
- ▼ 工作装置单手柄控制，操作舒适性好。
Single handle controlled working device
- ▼ 隔音降噪处理，整机驾驶室内噪音低，安全舒适。
Sound insulation noise reduction processed in cabin

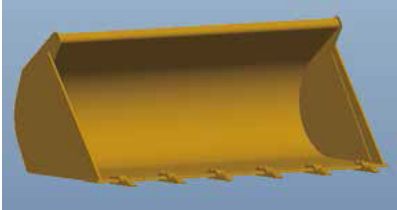

多种配置属具适应不同作业要求 Various attached tools for different working conditions

属具名称Attached tools		标准斗Standard bucket	
属具图片 Attached tool pics			
	斗容Bucket capacity	m ³	1.2
参数 parameters	外形尺寸(长×宽×高) Dimension (LxWxH)	mm	1120×2170×910
	属具重量weight	kg	370

属具名称Attached tools		粮食斗Grain bucket	
属具图片 Attached tool pics			
	粮食大斗斗容Big grain bucket capacity	m ³	1.6
参数 parameters	工程小斗斗容small engineering bucket capacity	m ³	1.0
	外形尺寸(长×宽×高) Dimension (LxWxH)	mm	1360×2260×1050
	属具重量weight	kg	480

属具名称Attached tools		标准斗Standard bucket	
属具图片 Attached tool pics			
	斗容Bucket capacity	m ³	1.0
参数 parameters	外形尺寸(长×宽×高) Dimension (LxWxH)	mm	1020×2060×820
	属具重量weight	kg	290

属具名称Attached tools		货叉fork	
属具图片 Attached tool pics			
	叉齿长度Fork teeth length	mm	1070
参数 parameters	外形尺寸(长×宽×高) Dimension (LxWxH)	mm	1630×1480×1250
	属具重量weight	kg	400

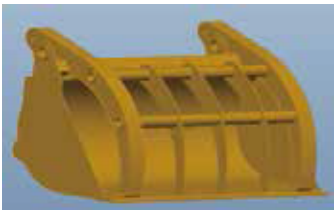

属具名称Attached tools		软包夹Soft clamp	
属具图片 Attached tool pics			
	外形尺寸(长×宽×高) Dimension (LxWxH)	mm	1520×1210×580
参数 parameters	属具重量weight	kg	240
	最大张开距离Max. opening dimension	mm	1500

属具名称Attached tools		限宽斗Limited width bucket	
属具图片 Attached tool pics			
	斗容weight	m ³	0.4/0.5
参数 parameters	外形尺寸(长×宽×高) Dimension (LxWxH)	mm	1020×1150/1170×820
	属具重量weight	kg	190/210

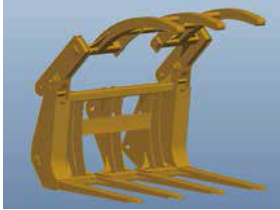
属具名称Attached tools		装夹斗Clamp bucket	
属具图片 Attached tool pics			
	斗容Bucket capacity	m ³	1.0
参数 parameters	外形尺寸(长×宽×高) Dimension (LxWxH)	mm	900×2060×910
	属具重量weight	kg	450
	张口尺寸Opening dimension	mm	1600

属具名称Attached tools		多齿抓草机grapple	
属具图片 Attached tool pics			
	外形尺寸(长×宽×高) Dimension (LxWxH)	mm	1440×1760×1160
参数 parameters	叉齿长度Grapple teeth length	mm	1000
	属具重量weight	kg	475
	最大张口尺寸Max. opening dimension	mm	1600
	最小抱圆直径Min. bearing circle diameter	mm	470

属具名称Attached tools		清扫器broomer	
属具图片 Attached tool pics			
	外形尺寸(长×宽×高) Dimension (LxWxH)	mm	1750×2215×880
参数 parameters	工作宽度Working width	mm	1830
	毛刷直径Broom diameter	mm	800
	属具重量weight	kg	450
	马达流量Motor flow	L/min	150
	驱动系统Drive system	/	液压马达直驱 Hydraulic motor directly drive

属具名称Attached tools		快换装置Attached tools		
属具图片 Attached tool pics				
				
参数 parameters	Quick change type 快换装置类型		快换铲斗 Quick change bucket	快换货叉 Quick change fork
	参数parameters			
	外形尺寸(长×宽×高) Dimension (LxWxH)	mm	1120×2060×900	1630×1200×1110
	斗容Bucket capacity	m ³	1.0	/
	叉齿长度Teeth length	mm	/	1050
属具重量(含托架)Weight(including bracket)	kg	450	430	

主要参数 Main parameters

项目items	短臂型 short boom	标准型 standard boom	高卸型 long boom	单位 units	
额定载荷Rated load	1300	1200	1100	kg	
倾翻载荷Tilt load	2600	2400	2200	kg	
卸载高度Discharge height	铲斗平高Bucket height	3470	3870	4300	mm
	标准standard	3000	3400	3830	mm
卸载距离Discharge distance	785	900	860	mm	
额定斗容Rated bucket capacity		1.0		m ³	
整机工作质量Machine working mass	4900	5100	5300	kg	
轴距Wheel base		2350		mm	
轮距Tread		1500		mm	
最大提升时的铰销高度Hinge angle at the highest lifting position	3730	4190	4530	mm	
最大掘起力Max. breakout force		44		kN	
动臂提升时间Boom lifting time	5.5	5.5	6.3	s	
三项和时间Total cycle time	9	9	11	s	
最小转弯半径(轮胎中心) Min. turning radius (tire center)		4620		mm	
铰接角度Hinge angle		35		°	
爬坡能力gradeability		23		°	
最小离地间隙Min. clearance to ground		220		mm	
轮胎规格Tire spec		16/70-16		-	
整机外形尺寸(长×宽×高) Machine dimension (LxWxH)	6150×2060×2930	6650×2060×2930	6800×2060×2930	mm	
发动机Engine	型号Model	YN38GBZ		-	
	额定功率/转速Rated power/rpm	73/2400		kW/rpm	
行驶速度	一档(前进/后退) Gear I(forward/reverse)	8		km/h	
Travel speed	二档(前进/后退) Gear II(forward/reverse)	20.5		km/h	

随技术进步, 样本内容、产品结构、配置参数等将不断改进, 恕不另行通知。样本信息与实物存在差异的, 以实物为准。
Sample book content, product structure and configurations may vary due to technical improvements.
The specific kind prevail if there are some difference exist.